

Fanuc M710iC/50 and M710iC/70

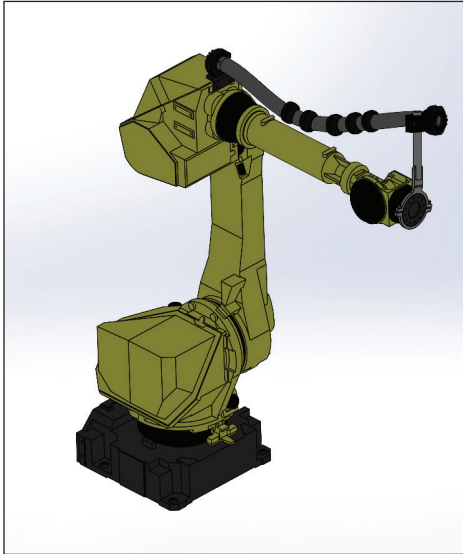

11.48.021.0 Complete robotic dresspack, Axis 3-6, without retraction system, high-flex conduit with ID 64mm

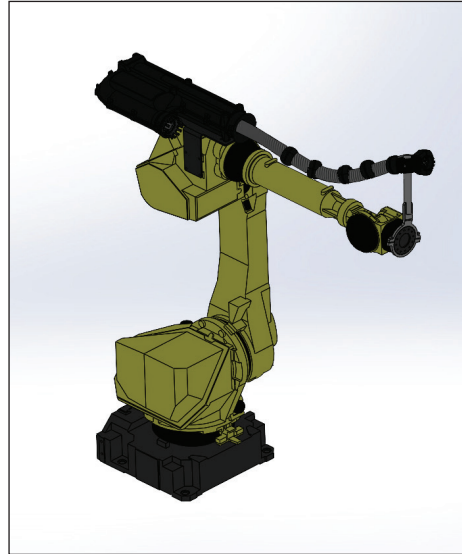

11.48.321.01 Complete robotic dresspack, Axis 3-6, Tecliner retraction system, 350mm stroke, high-flex conduit with ID 64mm











11.48.421.01 Complete robotic dresspack, Axis 3-6, TecBox retraction system, 600m stroke, high-flex conduit with ID 64mm

Product Information

Our robotic dresspacks offer effective cable protection for the most demanding robotic applications. Specifically designed for cable routing on Fanuc M710iC/50 and M710iC/70 robots, our dresspacks include mounting brackets, our high-flex EWX-PAE robotic conduit, effective strain relief and optionally, a retraction system for highly dynamic applications.

Conduit Specifications

-  Mod. Polyamide PA 12
-  According to IEC EN 61386
Crush Resistance: > 1200 N
-  According to IEC EN 61386
Cycles: > 5000000 ~
-  According to IEC EN 61386
Tier: 4
-  According to IEC EN 61386
System tear-out strength > 100 N
-  -40 - 120°F
Short Periods 150°F
-  acc. to UL94 HB
-  RoHS

Part Number	Axes	Robot Model	Conduit	Retraction System
11.36.021.01	A3-A6	Fanuc M710iC/50 and 70	EWX-PAE M40/P36	no retraction system
11.36.321.01	A3-A6	Fanuc M710iC/50 and 70	EWX-PAE M40/P36	TecBox, Size 36, 400mm
11.36.421.01	A3-A6	Fanuc M710iC/50 and 70	EWX-PAE M40/P36	TecLiner, Size 36, 400mm
11.48.021.01	A3-A6	Fanuc M710iC/50 and 70	EWX-PAE M50/P48	no retraction system
11.48.321.01	A3-A6	Fanuc M710iC/50 and 70	EWX-PAE M50/P48	TecBox, Size 48, 400mm
11.48.421.01	A3-A6	Fanuc M710iC/50 and 70	EWX-PAE M50/P48	TecLiner, Size 48, 400mm
11.70.021.01	A3-A6	Fanuc M710iC/50 and 70	EWX-PAE 70	no retraction system
11.70.121.01	A3-A6	Fanuc M710iC/50 and 70	EWX-PAE 70	TecLiner, Size 70, 350mm
11.70.221.01	A3-A6	Fanuc M710iC/50 and 70	EWX-PAE 70	TecLiner, Size 70, 550mm
11.70.321.01	A3-A6	Fanuc M710iC/50 and 70	EWX-PAE 70	TecBox, Size 70, 600mm

**Custom non-populated or fully populated dresspacks for any type of industrial robot along all axes can also be requested.*